

LIMITED WARRANTY

If your product does not work properly because of a defect in material or workmanship, Custom Autosound Mfg., Inc. (the Company) will for the length of the period indicated on the chart below, which starts with the date of original purchase ("Limited Warranty period"), at its option either (a) repair your product with new or refurbished parts, or (b) replace it with a new or refurbished product. The decision to repair or replace will be made by the company.

Product or Part Name	PARTS	LABOR
All In-dash car radios, radio/tape player combinations.	Two (2) Years	One (1) Year

During the "Labor" Limited Warranty period there will be no charge for labor. During the "Parts" Limited Warranty period, there will be no charge for parts. This Limited Warranty is extended only to the original purchaser and only covers product purchased as new. A purchase receipt or other proof of the original purchase date is required for Limited Warranty service.

To obtain repairs or replacement within the terms of this warranty, the product should be delivered, transportation prepaid, to the Company at the address shown below.

This warranty does not extend to the elimination of car static or motor noise correction antenna problems, costs incurred for removal or reinstallation of product, or damage of tapes, speakers accessories or car electrical systems.

This warranty does not apply to any product or part thereof which has been damaged through alteration, mishandling, misuse neglect, or accident.

ANY IMPLIED WARRANTY IS LIMITED TO THE DURATION OF THIS WRITTEN WARRANTY. UNDER NO CIRCUMSTANCES SHALL THE COMPANY BE LIABLE FOR ANY LOSS OR DAMAGE, DIRECT OR CONSEQUENTIAL, ARISING OUT OF THE USE OR INABILITY TO USE THIS PRODUCT: No person or representative is authorized to assume for the Company any liability other than expressed herein in connection with the sale of this product.

Some states do not allow limitations on how long an implied warranty last or the exclusion or limitation of incidental or consequential damage to the above limitations or exclusion may not apply to you.

This warranty gives you specific legal rights and you may also have other rights which vary from state to state.



1030 W. Williamson Ave. Fullerton CA. 92833
800-888-8637 714-773-1423 FAX 714-773-1523



Owner's Manual

ELECTRONICALLY TUNED AM/FM RECEIVER,
WITH AUXILIARY INPUT
CUSTOM MADE FOR
"THE GREAT CLASSIC VEHICLES!"

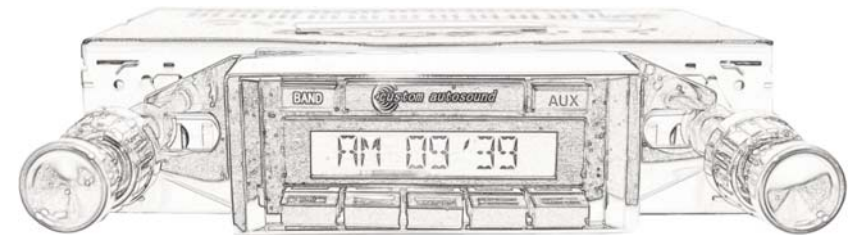

- ◆ ELECTRONIC VOLUME AND TUNING CONTROLS
- ◆ HIGH POWER 50 WATTS x 4
- ◆ AUXILIARY INPUT
- ◆ LEFT/RIGHT BALANCE CONTROL
- ◆ AUTO- ANTENNA DRIVE LEAD
- ◆ 4 Channel RCA PRE-AMP INPUTS
- ◆ 4AM 12FM STATION MEMORY
- ◆ SWITCHABLE USA/EURO FREQUENCY SELECTOR
- ◆ FRONT/REAR FADER

CONCOURS SERIES
USA-230



Table of Contents

Introduction	2
General Installation	3
Radio Connections	4
Low Level Output Connection	4
Wiring Diagram.	5
Controls and Display	6
Receiver Basic Operation	7
Programming The Preset Memory	7
Sound Adjustment	8
Setting the Clock	9
Digital Display	9
Noise Suppression	10-11
Trouble Shooting	12
Specifications	13

Radio Specifications

FM Section

Tuner TypePLL
Frequency Range87.5-108 MHz
Image Rejection50dB
Quieting Sensitivity4uV
T.H.D1%
IF Rejection60dB

AM Section

Frequency Range530-1710KHz
S/N Ratio50dB
Selectivity25dB

Audio Section

Output Channel50X4
Output Impedance4ohm per speaker
Response30Hz-18KHz

General

Power Supply12VDC Negative Ground
Speaker impedance4-8 ohm
Stand-By Current0.02A
Chassis 200mm(7 7/8")(w)X50(2 -1/4")mm
. X150(5 7/8")mm(D)

IF Frequency10.7MHZ
Sensitivity2.6V
S/N Ratio60dB
Capture Ratio1.5dB
Separation35dB

IF Frequency450KHz
Sensitivity20uV

System Power200 Watts
THD0.5%

Introduction

Thank you for your purchase of a Custom Autosound radio.

This factory made AM/FM receiver is specifically designed and manufactured for your classic special interest vehicle. It is a reflection of over 30 years of customer feedback regarding preferred features, vehicle compatibility, cosmetics and quality components.

The quality of the components and various parts that are used in our radios were developed in a California audio research laboratory. The laboratory researched and assembled the finest affordable radio tuner and amplifier sections.

Custom Autosound and its staff own over 16 classic special interest cars and trucks. These vehicles are used for research and development, car shows meets and much personal pleasure. We find that our custom radios only sound as good as the speakers they are matched with and a quality installation.

We also manufacture a full line of rear and dual front and dual voice coil speaker assemblies to fit in the original speaker areas, rear and overhead speaker assemblies and custom radios for over 300 different year groups and makes of classic vehicles plus Secretaudio the hideaway AM/FM CD Controller radio for any vehicle.

Your Custom Autosound authorized dealer has information regarding our speakers and special speaker assemblies, as well as information regarding custom radios for cars other than yours.

Again, we thank you for your purchase! You have increased the value and "Driving Pleasure" of your classic without damaging the originality.

Regards, Carl Sprague
President
Custom Autosound

It is advised that you do Not return defective units to your dealer. There is generally no "exchange" e.g.(as is standard Electronics Industry Policy). Also, most dealers do not have radio technicians, test benches, etc and a return to factory through a dealer can extend turn-around times by weeks!

Please call Custom Autosound, requesting technical assistance if a problem occurs. We will gladly trouble shoot/advise step by step.

If your unit is in need of repair, Please ship to us, UPS preferably. We will repair or replace and return ASAP! Normal turn around time is 7 business days plus shipping time.

Custom Autosound Mfg, Inc.
1030 West Williamson Ave
Fullerton, CA 92833

800-888-8637
Fax 714-773-1523
www.custom-autosound.com

General Installation

Thank you for your purchase of this Custom Autosound product!

Owner- Installer: Please review installation instructions and owners manual.

Keep in mind that your radio and/or speakers are custom equipment designed specifically for your year vehicle. It should be handled carefully and installed preferably by an auto radio specialist. We suggest that you "Bench Test" the unit before installation, as we do, prior to shipment. This is to insure that the equipment functions properly before the time is spent on installation. This way, if a careless installation occurs and the unit becomes "fried" or some other possible damage, the installer is responsible. Shipping damage does occasionally occur. If you should suspect shipping damage, please contact the delivery company at once.

Please read the owners manual thoroughly before using your radio.

It is recommended that you disconnect the negative lead from the battery before installing any electronic equipment in your vehicle. Reconnect when wiring is complete.

First, you will need to remove the knobs of your current radio, bezels and shaft nuts. Unplug the main wire harness and speaker leads from the back of the radio. Disconnect antenna lead and remove mounting strap from the back of the radio. The radio is now ready to be removed from the dash. Check the original radio for signs of water or oil damage from leaks. If leaks are present, do not install the new radio. Water, oil or any other liquid damage is not covered under the new radio warranty.

REAR MOUNTING STRAP OMISSION VOIDS WARRANTY!

Attach the rear mounting strap to rear of radio. Install the radio from behind the dash. Now attach the mounting strap to the dash or firewall using an existing bolt or screw. Now install any outer custom trim bezel, if one was furnished for this application and attach shaft nuts to secure the radio in the dash. Once the radio is centered and secured, you can install the knobs.

Please refer to wiring instructions on page 4&5.

Plug in antenna lead On speaker hook up make sure the positive lead goes to the positive terminal and the negative lead to the negative terminal of the speakers. A minimum of two (or one dual) speakers is required for this stereo radio. DO NOT CONNECT ANY TWO SPEAKER LEADS TO EACH OTHER OR TO VEHICLE GROUND. Radio damage will occur. If less than four speakers are used, tape off remaining speaker leads to prevent a short.

Plug in or wire the red power wire to a switched 12volt source. Plug in or wire the orange memory wire to a constant 12volt source. Wire the black ground wire to a clean, solid chassis point or original ground wire from the factory radio.

Good Listening! Audio quality is only as good as speaker quality!

Problem	Cause	Solution
NO Lights, NO Sound	Power Lead:Red Wire not connected or Power not getting to radio. Orange wire not connected or power not getting to radio.	Check both fuse's in filter box.Check all connections on these wires and verify that radio is getting 12Volts on both wires.
Lights but No Sound	Power Lead:Orange Wire not Connected or power not getting to radio	Check fuse in filter box.Check all connections on this wire and verify that radio is getting 12Volts on this wire
Lights,Numbers Displayed but No Sound	Problem with a speaker or speaker wire	Verify all speakers used are 4ohm or greater. Verify that none of the speakers are going to ground. Verify that none of the speaker wires are shorting to themselves or ground.
Sound only heard on one side Noise with Radio Reception	Speaker wires disconnected Balance control set to one side Antenna not fully extended Car underneath Fluorescent lights	Check all connections Adjust balance control to center position Extend antenna to full length. Back vehicle out of garage and test again

Power and Speaker Connections (Refer to Wiring Diagram on page 5.)

Antenna Noise

A static or crackle heard through the speakers, usually when the car is running, but sometimes present with the ignition off. If a crackling static is present, follow the steps outlined below to confirm the antenna as the source of the noise.

1. Start the car engine.
2. Switch on the USA-230.
3. Adjust the volume so that noise is audible.
4. Reduce volume setting of the car stereo but do not switch it off. If noise decreases or disappears, the signal is most likely being picked up by the car antenna. If the noise persists after following the steps listed below, proceed to Ignition Noise.

Elimination

1. Test or have tested the antenna lead for any breaks or shorts. Signs of crimping, kinking fraying or rust usually indicates damage to the cable. Replace the antenna or cable if necessary.

Ignition Noise

A popping or crackling noise heard through the speakers. The noise will vary as the engine rpm varies. The noise will Only be present with the engine running

Elimination

1. Install an L.C. Filter Network in the power lead of the USA-230. The filter should be rated at a minimum of 3 amps.
2. Inspect spark plug and distributor cable for signs of wear or damage. Replace as necessary using resistor cable only. Metal conductor ignition cables increase static interference.

NOTE: Do not use spark plug or distributor noise filters as these can create more problems than they can solve. They decrease the quality of the spark generated by the spark plugs and they may create more static than they eliminate.

Electrical Noise

A popping heard when the lights, turn indicators, windshield wipers, cigarette lighter, etc. are switched on indicate a vehicle wiring deficiency. Most occurrences are minor and present no risk to the stereo system other than the annoyance to the listener. However, severe cases may damage the speakers, minor occurrences can be remedied. A professional must attend to severe occurrences, as they present a threat to not only the stereo system but to the vehicle wiring itself.

Elimination

1. Install an L.C. Filter Network in the power leads of the USA-230. The filter should be rated at a minimum of 3 amps.
2. If the noise persists, consult a professional automotive service technician.

A-Main Power-Red Wire B+

Connect the RED wire (B+) to an accessory fuse that is switched OFF when the key switch is in the OFF position and is switched ON when the key switch is switched to the ON or accessory position. (This does not apply to cars with 6volt system)

B-Memory Back-Up-Orange Wire B+

Connect the orange wire (memory B+) to an accessory fuse that is always ON regardless of the position of the key switch. The lead supplies power to the program memory and the clock circuit when the USA-230 is switched off. (This does not apply to cars with 6volt system)

C-Power Antenna (Auto-Antenna) - Yellow Wire

This wire can be connected to the positive switch terminal of the relay for the auto antenna (if your car is equipped)or to the remote on switch of the amplifier or booster (if equipped). NOTE:DO NOT connect this wire to a negative position or to any device that requires high current Otherwise the radio may fail or become "fried". If your car is not equipped with an auto antenna,leave this wire sealed and do not allow it to short to any other positions.

D - Ground Wire - Black

Connect the black ground wire to any clean paint and contaminant free area of vehicle chassis.

NOTE: Proper grounding is essential for optimum performance of your radio.

E - Speaker Wires

Connect the speaker wires as shown in Figure 1.

Low Level Output (Line Out Jacks) Connection

The USA-230 is equipped with low level, high impedance outputs. The low level outputs (RCA type Line Out Jack) will not drive speakers. If you are connecting an amplifier or plan on it in the future, it is recommended to use these leads. It makes for a cleaner and easier Installation.

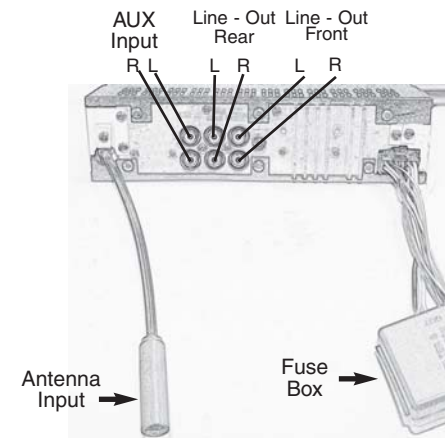

WIRING DIAGRAM

FIGURE 1.

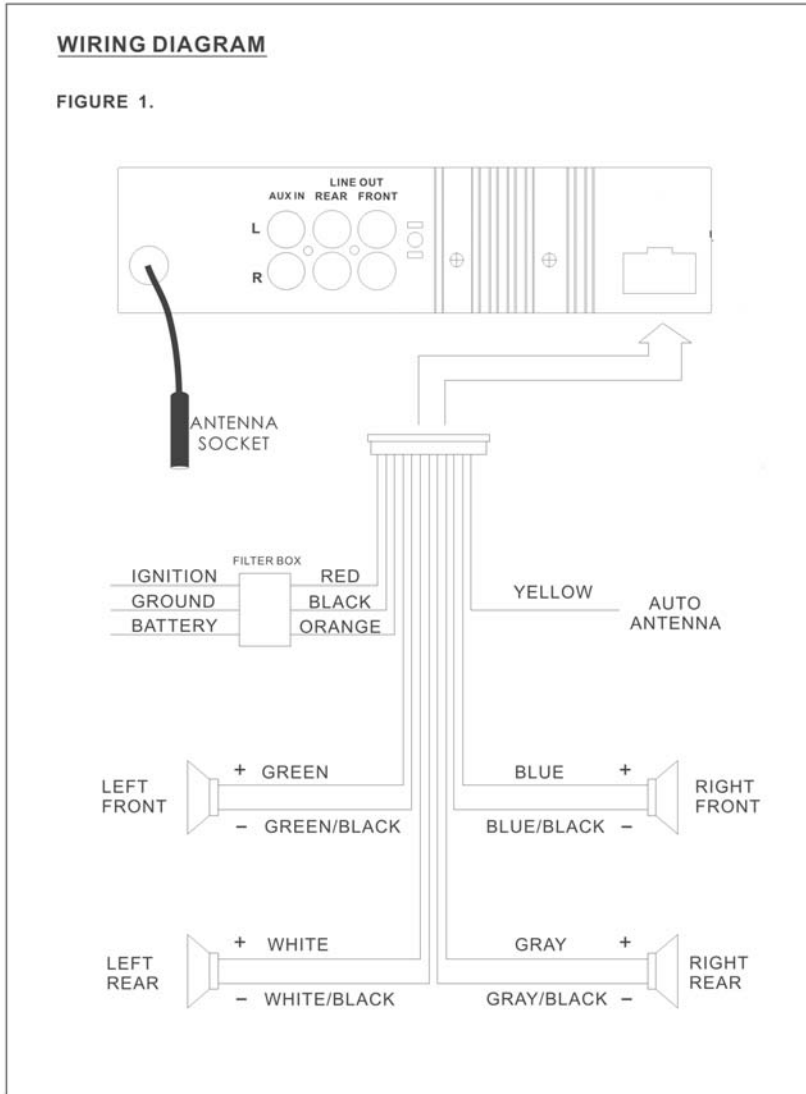

Noise Suppression

All CAM Systems are designed for maximum electrical noise rejection. In some installations however, electrical noise may affect the quality of sound reproduction.

If noise is present after installing the USA-230, identify the source of the noise using the descriptions under Sources Of Electrical Noise. To eliminate the noise follow the procedures described under Elimination of the specific noise source.

Noise Suppression

- 1-Check all ground connections. Remove paint from painted surfaces to secure a good electrical ground.
- 2-Check battery posts. If contacts are corroded or loose, clean and tighten both terminals.
- 3-Check battery or add fluid.
- 4-Check condition of spark plug and distributor leads. Worn or damaged leads will generate noise than can be very difficult to eliminate.
- 5-Check installation of factory noise suppressor(s). Verify that the connections are solid. Refer to the vehicles service manual for nose suppressor location or allow a qualified mechanic to inspect the device(s) for you.
- 6-(Optional) Some professional installers will install a simple L.C. noise filter even if there is no noise present in the system. This is a simple and relatively inexpensive device available at your nearest Autosound dealer or electronic supply store. Most filters designed for car stereos carry a current rating of 3 amps or more. Follow the manufacturers installation instructions. This filter is installed in the power lines of the car stereo.

Sources Of Electrical Noise

Alternator Noise

This noise is generally a high pitch whine present with the engine running. The pitch of the whine will vary as engine RPM varies. Alternator noise usually becomes more apparent with an electrical load to the system. Switching the headlights on usually increases the noise.

Elimination

1. Install an L.C. noise filter (available from your Autosound dealer or your nearby electronic or automotive supply store) in the power lines of your USA-230. This filter should be rated at 3 amps minimum.
2. Start the car's engine. switch on the lights (to accentuate the noise) and switch on the USA-230. If noise is still present, proceed to step 3.
3. Install an alternator noise filter (available from your Autosound dealer or your nearby electronic or automotive supply store). Follow manufacturer's installation instructions.

Setting The Time

The following procedure must be performed with the radio ON.

1. With the unit on press and release the Time/Frequency Recall Button (5) so the time is displayed.
2. Press and hold in the Time/ Frequency Recall Button (5) for 5 seconds. The hour and minutes should be blinking on the display. Release the button and rotate the Manual Tuning Control (4) gently to the right, the Hour will advance. Rotating the Manual Tuning Control (4) gently to the left, the Minutes will advance. You may have to advance completely through the AM or PM hours to get the proper Hour.
4. When finished setting the time, do not touch the radio. The hours and the minutes will stop blinking, the clock will show on the display for 5 seconds, and then will revert back to the radio station display.

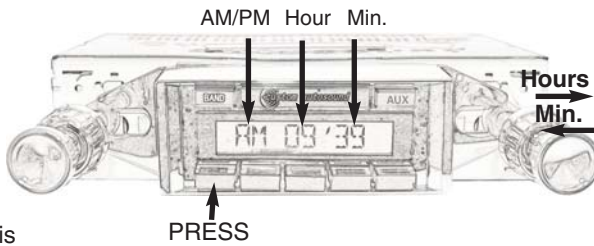

Digital Display

The USA-230 features a multi-mode liquid crystal digital display(10). It will perform as follows under various operating conditions (Page 7).

1. When the USA-230 is switched OFF and/or ignition key is switched OFF the internal circuitry will continue to keep the stations that you have preset.
2. When the USA-230 is switched ON in the radio mode, the display will indicate the currently tuned station. The time can be recalled by pressing the Menu button (5) The radio will revert back to the current station display after approximately 5 seconds.

Receiver Special Functions

1. Automatic Mono/Stereo(Built-In)& Stereo Indicator

The built-in Automatic Mono/Stereo (FMO -Frequency Modulation Optimizer) is used to improve stereo FM reception in weak signal areas without manually changing the mode.

When the FM station is too weak to receive a clear stereo signal, and noise and interference increases, the USA-230 will change its mode to Mono automatically. When the USA-230 is tuned to a strong FM signal, the Stereo Indicator (fig.4) will appear on the LCD.

2. USA/EURO FREQUENCY SELECTOR

This feature is used to select how the radio receives signals for either USA or European channel spacing. see fig.2

- (1) Disconnect the main power and the memory power.
- (2) Move the channel space switch to "USA" position. This changes the channel space to 200KHz for FM and 10KHz for AM. Move channel space switch to "EUR" position to change the channel space to 50KHz for FM and 9KHz for AM.

CONTROLS

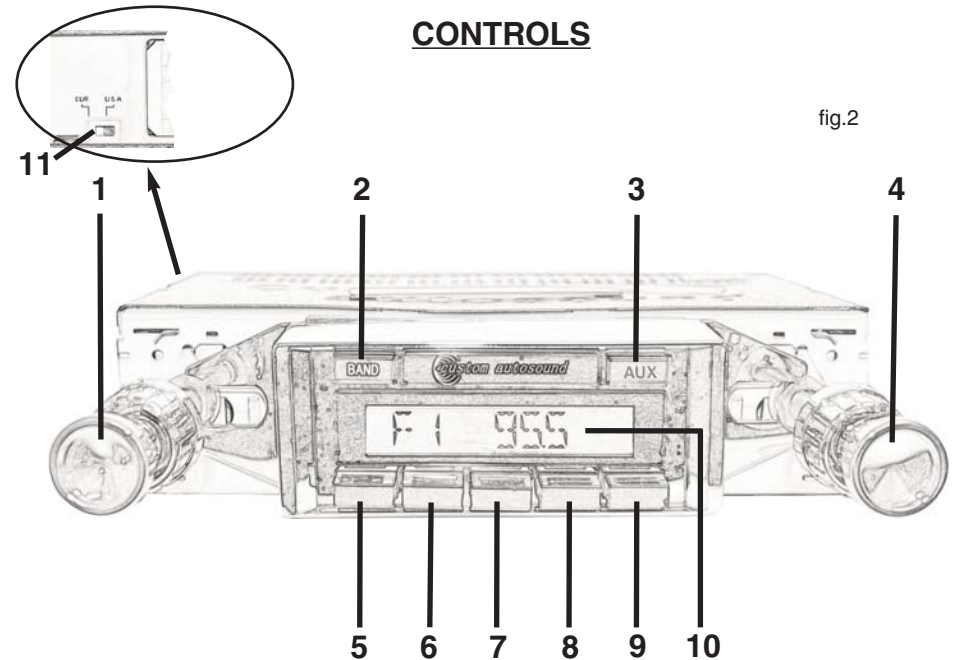
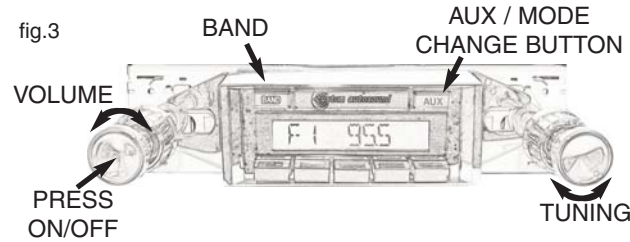

fig.2

1. PUSH-POWER ON/OFF -- TURN VOLUME CONTROL
2. AM/FM1/FM2/FM3 BAND SELECT
3. AUX-IN / RADIO SELECT
4. SEEK/MANUAL UP-DOWN TUNING CONTROL / CLOCK ADJUST
PUSH SELECT FUNCTION CONTROL
5. TIME/FREQUENCY RECALL BUTTON
6. PRE-SET 1
7. RADIO PRE-SET 2
8. RADIO PRE-SET 3
9. RADIO PRE-SET 4
10. FREQUENCY DISPLAY / CLOCK
11. USA / EUROPE FREQUENCY CHANGE

Receiver Basic Operation

1. Switch the receiver "ON" by depressing the Power ON/OFF Volume control knob (1).
2. Depress the Band Selector (3) to the desired position. In the AM mode, AM will be visible in the LCD display (10). In the FM mode, one of FM1, FM2 or FM3 will appear on the LCD Display (10).



3. Depress the AUX button (4) to toggle the functions of the radio. The sequence displayed will be : Radio—AUX—Radio.

Radio Station Tuning

Seek Tuning:

To tune the receiver a slight turn and release will seek the next available radio station. A clockwise rotation tunes the radio up-wards and counter clockwise tunes the radio downwards.

Manual Tuning:

To manually tune the receiver a slight turn and hold (the lcd display will show (MANUAL) until the desired station is shown on the display. The tuner will stay in manual mode for 5 seconds unless the tuning knob is turned again. After 5 seconds the tuning will revert to auto seek.

Programming The Preset Memory

The USA-230 features 4 AM and 12 FM station memory presets. Using the buttons (6) thru (9) located across the bottom of the display will access these presets.

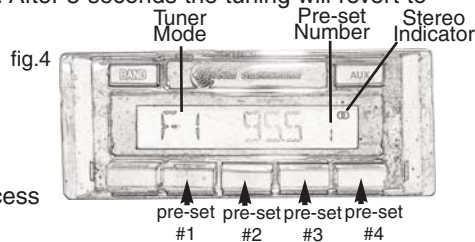

A-FM Programming

1. Set the Band Selector (2) in the FM position (one of the FM bands) and view the FM Band Indicator on the LCD Display(10).
2. Select the station desired by using the Manual UP- Down Tuning Control (4)
3. Depress one of the 4 preset buttons (6-9) for approximately 5 seconds. The sound will fade out momentarily and return again. The station is now programmed at that button and the Preset Channel will appear on the LCD display (10).
4. Repeat above 2-3 steps to program another station on another button. Repeat above steps until 4 stations are programmed in FM 2 and 4 in FM 3 for a total of 12 stations.

B-AM Programming

1. Repeat the steps 2-3 above but with the Band Selector (2) in the AM band.

Sound Controls

Pressing tuning knob (4) will toggle the LCD display in this order - (VOL)--(BAS)--(TRB)--(BAL L_R)--(FAD F_R). If an adjustment is not made or the tuning knob not pressed for 5 seconds the display will revert to regular function.

Adjust Balance (Left to Right)

1. Press tuning knob (4) until the display shows BAL L-R.
2. Rotate volume control knob (1) to adjust the speaker balance from left to right.

The display will read from 10L to 10R or L--R if set in the middle. Adjust the balance until you can hear speakers evenly from both sides.



Adjust Fader (Front to Rear) in 4 speaker system

1. Press tuning knob (4) until the display shows FAD F--R.
2. Rotate the volume control knob (4) to adjust the sound from front to rear. The display will read 10F to 10R or F--R if set in the middle. Adjust balance until you can hear speakers evenly from front and rear.



Adjust Bass

1. Press tuning knob (4) until the display shows BAS.
2. Rotate volume control knob (1) clockwise to increase bass and counter clockwise to decrease. Be aware that a bass level that is too high may cause distortion from your speakers.



Adjust Treble

1. Press tuning knob (4) until the display shows TRB.
2. Rotate volume control knob (1) clockwise to increase treble and counter clockwise to decrease. Be aware that a treble level that is too high may cause distortion.

